

RADIAL FAN WITH FORWARD CURVED BLADES

Радиальный вентилятор с вперед загнутыми лопатками

Radialventilator mit vorwärts gekrümmten Schaufeln

Wentylator promieniowy z łopatkami pochyłonymi do przodu



Motor type:

Voltage / Напряжение / Spannung / Napięcie znamionowe:

Maximum pressure / Полное давление / Maximaler Druck / Spręż max.:

Max. air flow / Макс. производ. / Max Luftfördermenge / Wydatek max.:

Speed / Частота вращения / Drehzahl / Prędkość obrotowa:

Power input / Входная мощность / Leistungsaufnahme / Moc pobierana:

Weight / Масса / Gewicht / Masa:

Material of impeller / Материал ротора
/ Laufradmateriал / Materiał wirnika:

Flange / Фланец / Flansche / Kołnierz:

Size and holes can be adapted to the requirements

/ Размер и отверстия могут быть адаптированы к требованиям

/ Größe und Bohrungen kann den Anforderungen angepasst werden

/ Rozmiar i otwory mogą być dostosowane do wymagań

Fan dimensions / Размеры вентилятора

/ Lüfterabmessungen / Wymiary wentylatora:

Connection diagram / Схема подключения

/ Anschlussbild / Schemat połączenia:

Curves / Характеристика / Curves / Charakterystyka:

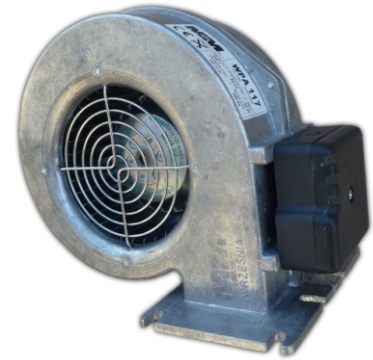

R2E 120-AR87-37

230V/50Hz

280 Pa

180 m³/h

1650 rpm

34 W

2,10 kg

galvanized steel / оцинкованная сталь
/ verzinkter Stahl / stal cynkowa

WPA HL 117

possible variant of a motor
(R2E 120-AR87-43)
with Hall sensor

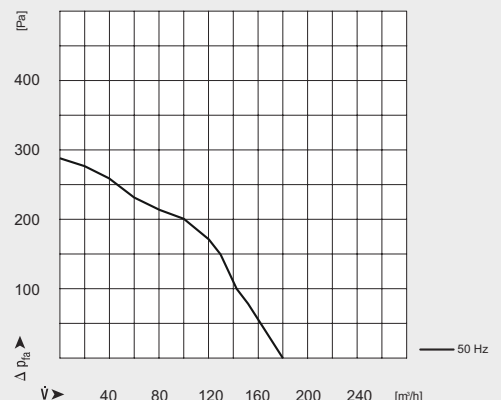
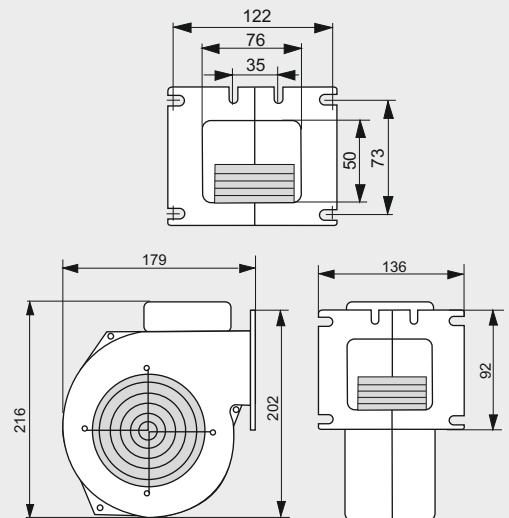

Screen / Диафрагма / Blende / Przystłona:

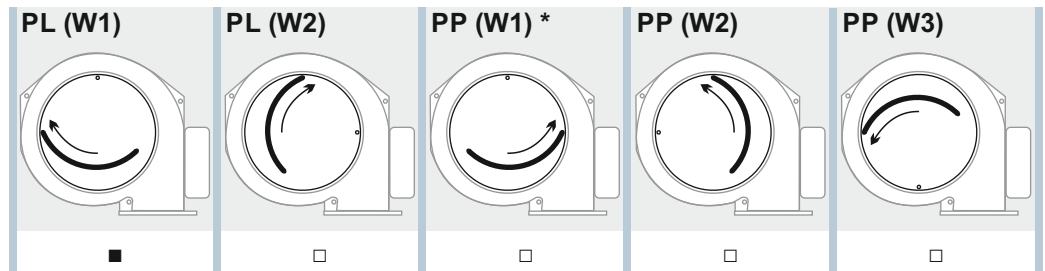
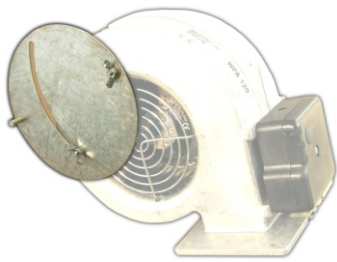

* PP(W1) - collision with normal valve KZW

Valve / Заслонка / Klappe / Klapka:

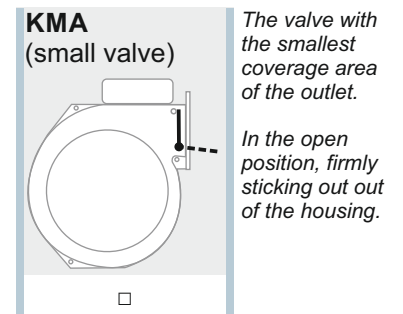
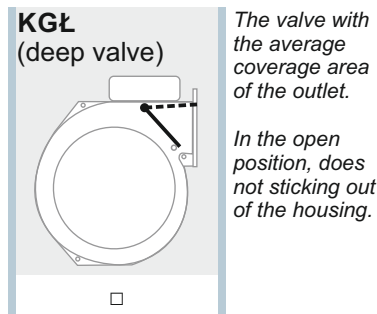
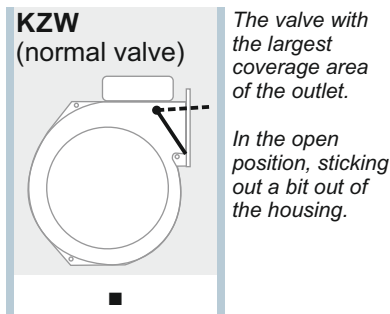

Terminal box / Клеммная коробка / Schaltschrank / Puszka elektryczna:

Upper assembly,
with hole for the power cord

Side assembly,
with IEC socket

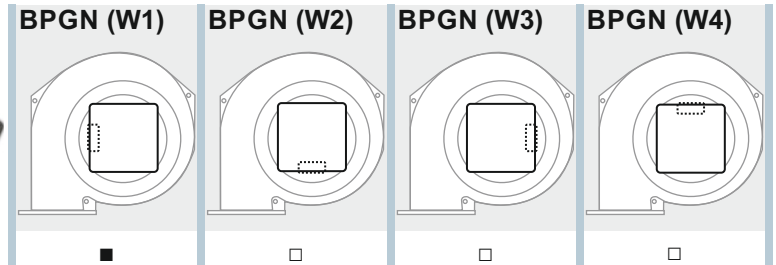
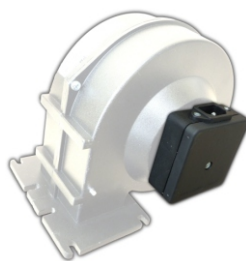
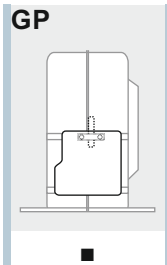
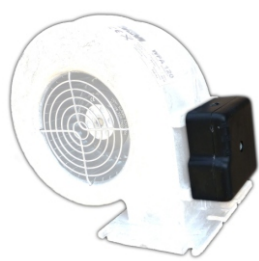

Upper assembly,
with IEC socket

Side assembly,
with hole for the power cord

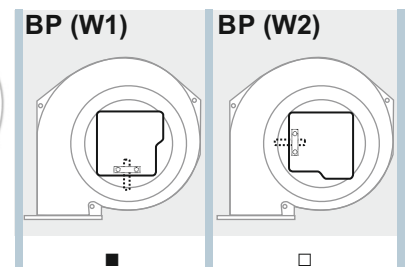
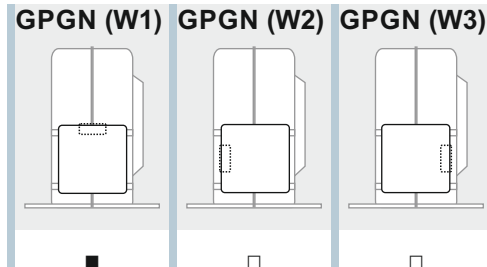

Power cable / Кабель питания / Stromkabel / Kabel sieciowy:



+0,15m
+0,30m
+0,80m
+1,60m
+2,00m
+2,50m
+3,00m

■

Gasket / Уплотнение / Dichtung / Uszczelka:



U

flange gasket
made of
cork-rubber
blend

■

Housing painted / Корпус окрашен / Cover lackiert / Malowana obudowa:



M

black
semi-gloss

powder coating

■